

mitsubishi

三菱工業用ミシンプリント基板搭載部品カタログ Industrial Sewing Machine Control Unit Electronics Parts List on P.W.B

Model PLK-E

目次	INDEX	Page
[A] プリント基板[PLK-B1-CPU-E,PLK-B-DISP] 上の主要部品	MAIN PARTS ON CIRCUIT BOARD [PLK-B1-CPU-E, PLK-B-DISP].....	1
[B] プリント基板[PLK-B1-PMD-E]上の主要部品	MAIN PARTS ON CIRCUIT BOARD [PLK-B1-PMD-E].....	3
[C] プリント基板[PLK-E-CON]上の主要部品	MAIN PARTS ON CIRCUIT BOARD [PLK-E-CON].....	5
[D] プリント基板[PLK-B1-FIL]上の主要部品	MAIN PARTS ON CIRCUIT BOARD [PLK-B1-FIL].....	7
索引	INDEX.....	13

[A] プリント基板 [PLK-B1-CPU-E, PLK-B-DISP] 上の主要部品

MAIN PARTS ON CIRCUIT BOARD [PLK-B1-CPU-E, PLK-B-DISP]

PLK-B1-CPU-E

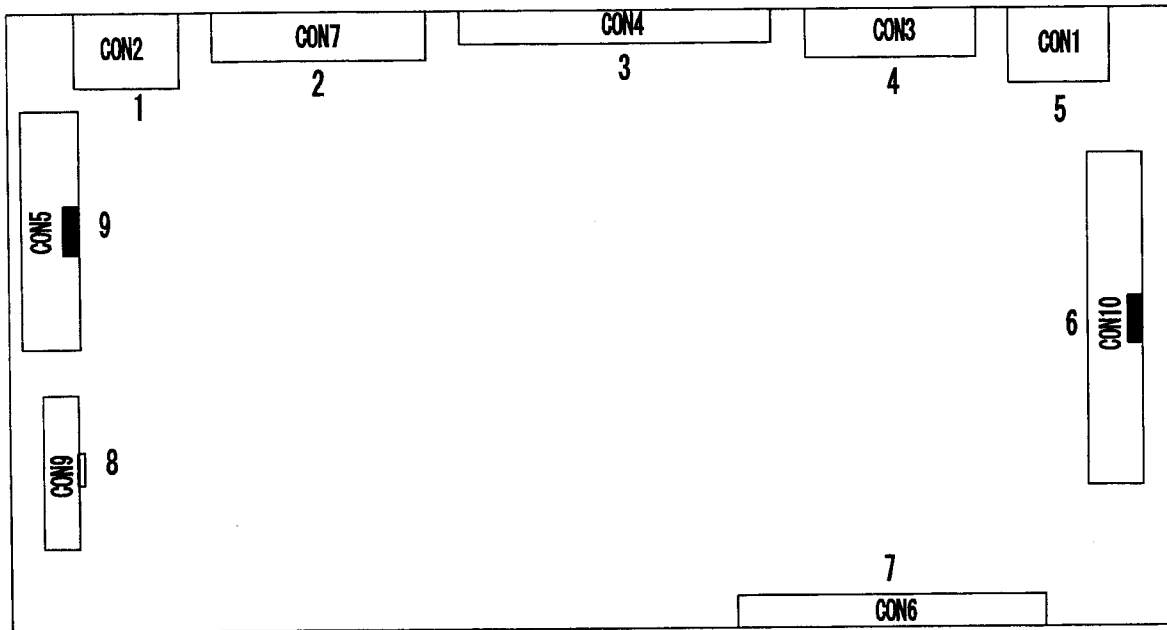

PLK-B-DISP

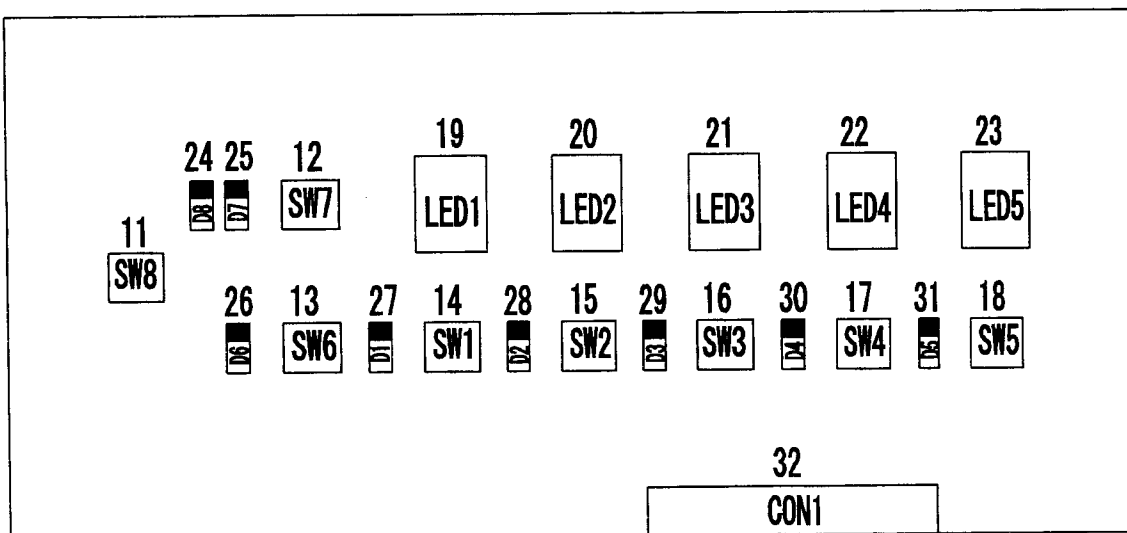

[A] プリント基板[PLK-B1-CPU-E, PLK-B-DISP]上の主要部品
 MAIN PARTS ON CIRCUIT BOARD [PLK-B1-CPU-E, PLK-B-DISP]

Fig. No.	変更 No.	部品コード Parts.No.	部品名	Description	使用個数 Amt.	Reg.	資材コード Ref.No.
PLK-E							
A001		K14M95055100	コネクタ(CON2)	Connector[TCS4450-01-4051]	1	-	P950A551P00
A002		K14M95067400	コネクタ(CON7)	Connector[178238-5]	1	-	P950C674P00
A003		K14M95000935	コネクタ(CON4)	Connector[XG4A-2634]	1	-	P950K009P35
A004		K14M95062500	コネクタ(CON3)	Connector[178238-4]	1	-	P950C625P00
A005		K14M95067100	コネクタ(CON1)	Connector[TCS4480-01-4051]	1	-	P950C671P00
A006		K14M95000937	コネクタ(CON10)	Connector[XG4A-5031]	1	-	P950K009P37
A007		K14M95067300	コネクタ(CON6)	Connector[00-8263-1511-00-000]	1	-	P950C673P00
A008		K14M95086400	コネクタ(CON9)	Connector[FCN-794P020-L/O]	1	-	P950B864P00
A009		K14M95000936	コネクタ(CON5)	Connector[XG4A-3431]	1	-	P950K009P36
A011~A018		K14M42928600	スイッチ(SW1~SW8)	Switch[SKHHAK]	1	-	P429A286P00
A019~A023		K14M16621800	発光ダイオード(LED1~LED5)	LED[LA-301VB]	1	-	P166A218P00
A024~A031		K14M16018200	ダイオード(D1~D8)	Diode[1SS119TA]	1	-	P160A182P00
A032		K14M95066900	コネクタ(CON1)	Connector[FCN-795P020-L/O]	1	-	P950C669P00

From the library of: Diamond Needle Corp

[B] プリント基板 PLK-B1-PMD-E 上の主要部品

MAIN PARTS ON CIRCUIT BOARD PLK-B1-PMD-E

PLK-B1-PMD-E

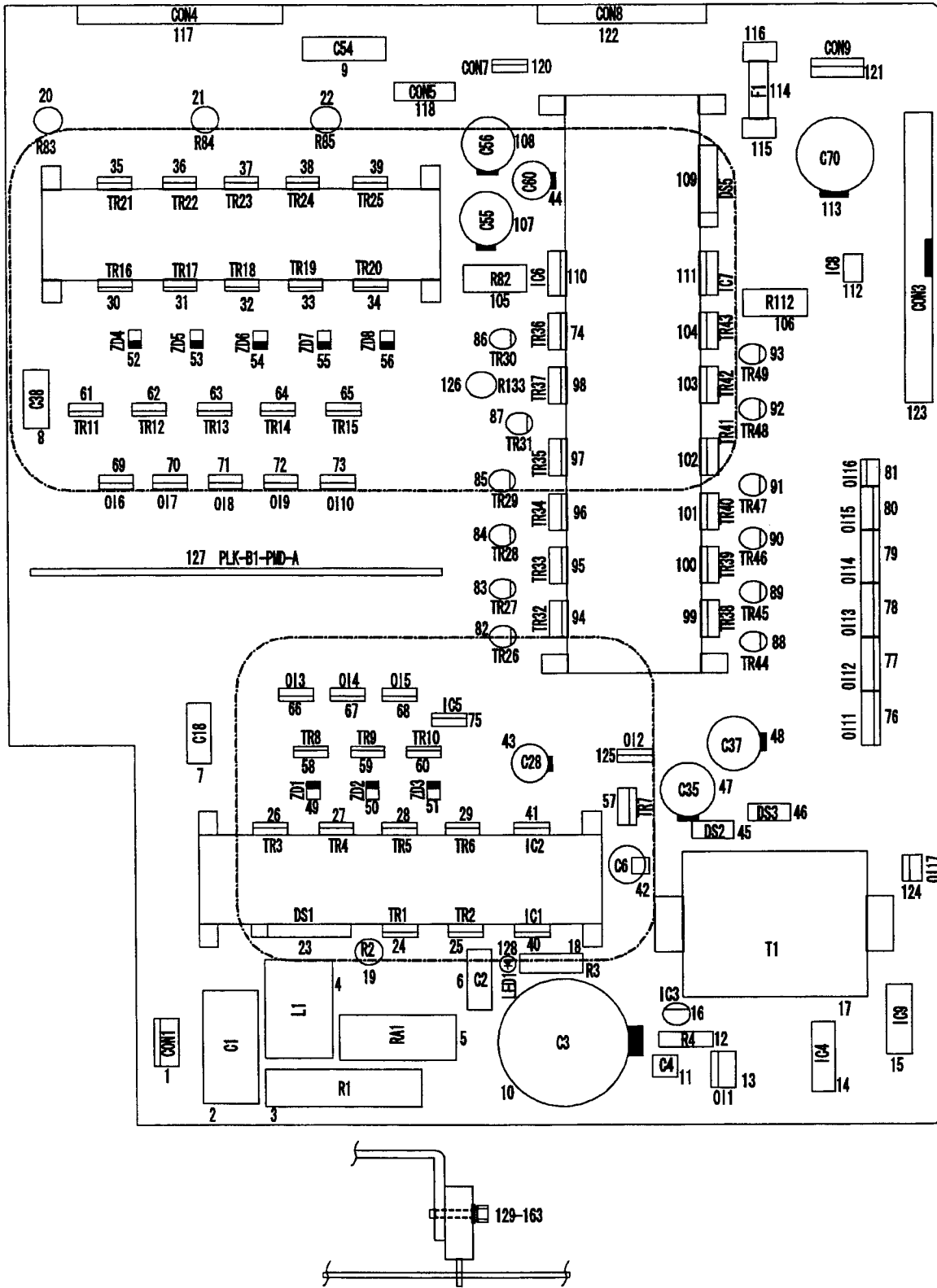

[B] プリント基板 [PLK-B1-PMD-E]上の主要部品
 MAIN PARTS ON CIRCUIT BOARD [PLK-B1-PMD-E]

Fig. No.	変更 No.	部品コード Parts.No.	部品名	Description	使用個数 Amt.	資材コード Ref.No.
					PLK-E	
		B001	K14S95026144 コネクタ(CON1)	Connector[5281-04A]	1	S950N261P44
		B002	K14M11018100 コンデンサ(C1)	Capacitor[ECQ-E2A105R37]	1	P110A181P00
		B003	K14M10087500 15W, 390Ω (R1)	15W, 390Ω [MPS15N390K]	1	P100D875P00
		B004	K14M19030500 インダクタ(L1)	Inductor[NF10KL102W-20]	1	P190A305P00
		B005	K14M40079900 リレー(RA1)	Relay[G4A-1A DC12V]	1	P400A799P00
		B006~B009	K14M11038600 コンデンサ(C2, C18, C38, C54)	Capacitor[630MMW334KEF]	4	P110B386P00
		B010	K14M11001157 コンデンサ(C3)	Capacitor[LLQ2W471MHLEQR]	1	P110K011P57
		B011	K14M11054800 コンデンサ(C4)	Capacitor[MDD21H105K5-FT]	1	P110B548P00
		B012	K14M10001300 抵抗 30mΩ (R4)	Resistor[RKP30MILIOHM]	1	P100D013P00
		B013	K14M18618500 ホトカテラ(OI1)	Photo IC[HCPL-7800]	1	P186A185P00
		B014	K14M21024500 IC4	IC[NJM319D]	1	P210D245P00
		B015	K14M21722500 IC9	IC[MC74HC08AN]	1	P217A225P00
		B016	K14M21001107 3端子レギュレータ(IC3)	Regulator[NJM78L05A]	1	P210K011P07
		B017	K14M62434200 トランス組立(T1)	Transformer	1	P624A342P00
		B018	K14M10007300 3W, 220Ω (R3)	3W, 220Ω [SPR3L20-220KOHMJ]	1	P100C073P00
		B019~B022	K14M10078400 3W, 1Ω (R2, R83, R84, R85)	3W, 1Ω [RSSX3U-1OHMJ]	4	P100D784P00
		B023	K14M16043700 ダイオードスタック(DS1)	Diode[D15XB60]	1	P160A437P00
		B024~B039	K14M15055100 トランジスタ(TR1-TR6, TR16-TR25)	Transistor[FK10KM-12]	16	P150A551P00
		B040, B041	K14M21001106 3端子レギュレータ(IC1, IC2)	Regulator[NJM7812FA]	2	P210K011P06
		B042~B044	K14M11001208 コンデンサ(C6, C28, C60)	Capacitor[KMF63VB100M]	3	P110K012P08
		B045, B046	K14M16043800 ダイオードスタック(DS2, DS3)	Diode[S1WBA20]	2	P160A438P00
		B047, B048	K14M11050900 コンデンサ(C35, C37)	Capacitor[CEDFM1H222M9]	2	P110C509P00
		B049~B056	K14M16210300 定電圧ダイオード(ZD1-ZD8)	Diode[RD5.1FB2]	8	P162A103P00
		B057~B065	K14M15000256 トランジスタ(TR7-TR15)	Transistor[2SJ181L]	9	P150K002P56
		B066~B073	K14M18620900 ホトカテラ(OI3-OI10)	Photo IC[TLP251]	8	P186A209P00
		B074	K14S15379501 トランジスタ(TR36)	Transistor[2SD1795]	1	S153N795P01
		B075	K14M21001108 3端子レギュレータ(IC5)	Regulator[NJM78M05FA]	1	P210K011P08
		B076~B079	K14M18602500 ホトカテラ(OI11-OI14)	Photo IC[PS2501-4]	4	P186A025P00
		B080	K14M18611400 ホトカテラ(OI15)	Photo IC[PS2501-2]	1	P186A114P00
		B081	K14S18600139 ホトカテラ(OI16)	Photo IC[PS2501-1]	1	S186N001P39
		B082~B093	K14M15037600 トランジスタ(TR26-TR31, TR44-TR49)	Transistor[2SA1318TU]	12	P150A376P00
		B094~B104	K14M15021300 トランジスタ(TR32-TR35, TR37-TR43)	Transistor[2SD1830]	11	P150A213P00
		B105, B106	K14M10014700 5W, 0.1Ω (R82, R112)	5W, 0.1Ω [MNS05NR10J]	2	P100A147P00
		B107, B108	K14M11050800 コンデンサ(C55, C56)	Capacitor[CEDFM1E222M8]	2	P110C508P00
		B109	K14M16043600 ダイオードスタック(DS5)	Diode[D10XB20]	1	P160A436P00
		B110, B111	K14M21000021 IC6, IC7	IC[NJM7805FA]	2	P210K000P21
		B112	K14M21024400 IC8	IC[NJM2903D]	1	P210D244P00
		B113	K14M11000878 コンデンサ(C70)	Capacitor[63VSSN2200M]	1	P110K008P78
		B114	K14S46001138 ヒューズ 8A(F1)	Fuse[MF60NR-8A-05]	1	S460N011P38
		B115, B116	K14M46018200 ヒューズクリップ	Fuse clip[F07P]	2	P460A182P00
		B117	K14M95055400 コネクタ(CON4)	Connector[640584-1]	1	P950C554P00
		B118	K14M95055300 コネクタ(CON5)	Connector[350210-1]	1	P950C553P00
		B120	K14M95034100 コネクタ(CON7)	Connector[171825-4]	1	P950B341P00
		B121	K14S95026143 コネクタ(CON9)	Connector[5281-03A]	1	S950N261P43
		B122	K14M95083800 コネクタ(CON8)	Connector[RDAG-15SE1-LNA-W2]	1	P950B838P00
		B123	K14M95000937 コネクタ(CON3)	Connector[XG4A-5031]	1	P950K009P37
		B124	K14M18603500 ホトカテラ(OI17)	Photo IC[TLP520]	1	P186A035P00
		B125	K14M18617400 ホトカテラ(OI2)	Photo IC[TLP559]	1	P186A174P00
		B126	K14M10086700 3W, 33Ω (R133)	3W, 33Ω [SPR3U-33OHMJ]	1	P100D867P00
		B127	M80AB1PMD プリント基板(PLK-B1-PMD-A)	P.C.B. [PLK-B1-PMD-A]	1	E738P085G12
		B128	K14M16607400 発光ダイオード(LED1)	LED1[GL3PR8T]	1	P166A074P00
		B129~B163	K14S90345921 SW-PW付 十字穴付六角ボルト	Bolt with SW&PW M3X8	34	S903N459P21

[C] プリント基板 PLK-E-CON 上の主要部品

MAIN PARTS ON CIRCUIT BOARD PLK-E-CON

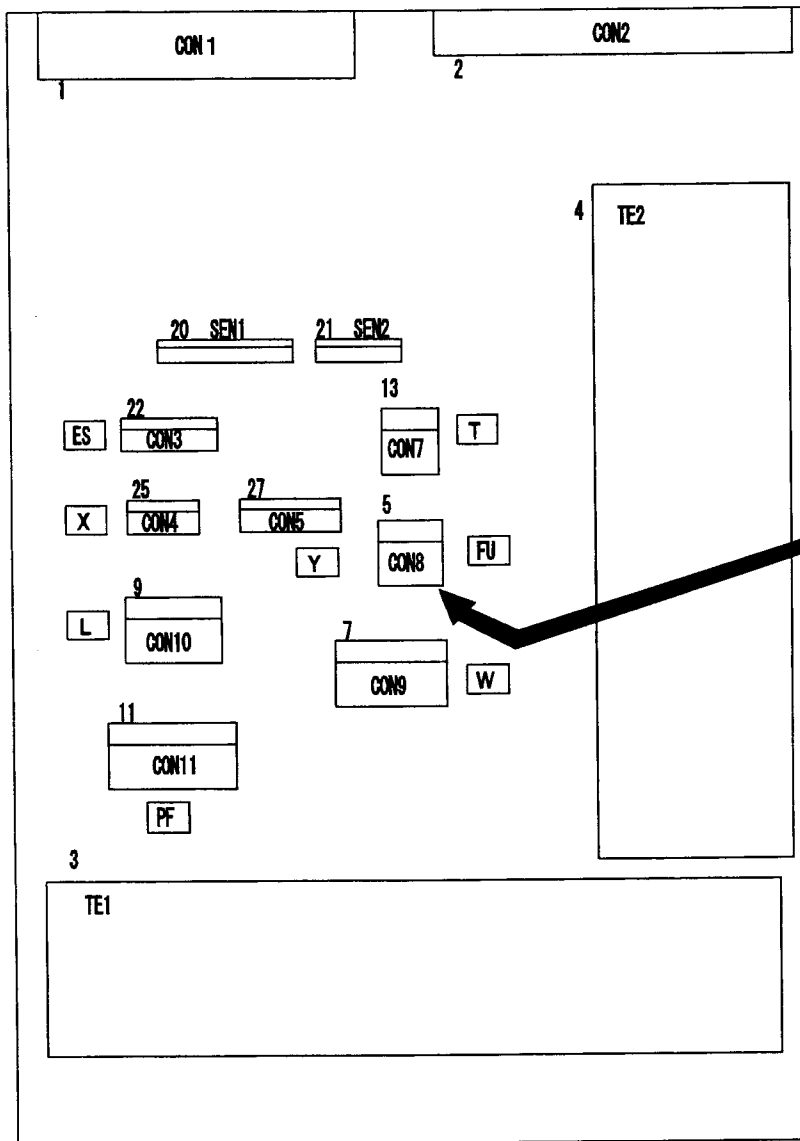

他のコネクタについては下記表を参照してください。

Other connectors: Refer to under the table.

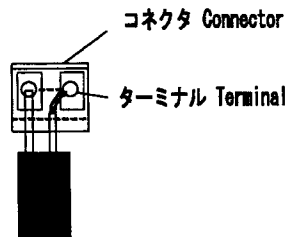

	コネクタ Connector Fig. No.	ターミナル Terminal Fig. No.
CON3	23	24
CON4	26	29
CON5	28	30
CON7	14	19
CON9	8	16
CON10	10	17
CON11	12	18

[C] プリント基板 [PLK-E-CON]上の主要部品
MAIN PARTS ON CIRCUIT BOARD [PLK-E-CON]

Fig. No.	変更 No.	部品コード Parts.No.	部品名	Description	使用個数 Amt.	資材コード Reg. Ref.No.
						PLK-E
	C001	K14M95062500	コネクタ(CON1)	Connector[178238-4]	1	P950C625P00
	C002	K14M95083800	コネクタ(CON2)	Connector[RDAG-15SE1-LNA-W2]	1	P950B838P00
C003, C004		K14M94300244	端子台 (TE1, TE2)	Terminal[KE232-20]	2	P943K002P44
	C005	K14S95026142	コネクタ(CON8:[FU])	Connector[5281-02A]	1	S950N261P42
	C006	K14M95009500	コネクタ(CON8:[FU])	Connector[5197-02]	1	P950B095P00
	C007	K14S95026103	コネクタ(CON9:[W])	Connector[5273-03A]	1	S950N261P03
	C008	K14M95000020	コネクタ(CON9:[W])	Connector[5195-03]	1	P950F000P20
	C009	K14M95068400	コネクタ(CON10:[L])	Connector[5277-02A-BU]	1	P950C684P00
	C010	K14M95000164	コネクタ(CON10:[L])	Connector[5196-02-BU]	1	P950F001P64
	C011	K14S95026143	コネクタ(CON11:[PF])	Connector[5281-03A]	1	S950N261P43
	C012	K14M95000146	コネクタ(CON11:[PF])	Connector[5197-03]	1	P950F001P46
	C013	K14M95068300	コネクタ(CON7:[T])	Connector[5273-02A-BU]	1	P950C683P00
	C014	K14M95000163	コネクタ(CON7:[T])	Connector[5195-02-BU]	1	P950F001P63
	C015	K14M95009700	ターミナル(CON8:[FU])	Terminal[5225TL]	2	P950B097P00
	C016	K14M95009700	ターミナル(CON9:[W])	Terminal[5225TL]	2	P950B097P00
	C017	K14M95009700	ターミナル(CON10:[L])	Terminal[5225TL]	2	P950B097P00
	C018	K14M95009700	ターミナル(CON11:[PF])	Terminal[5225TL]	2	P950B097P00
	C019	K14M95009700	ターミナル(CON7:[T])	Terminal[5225TL]	2	P950B097P00
	C020	K14M71928130	接続電線 (SEN1)	Cord	1	E719D281G30
	C021	K14M71626035	接続電線 (SEN2)	Cord	1	E716D260G35
	C022	K14M95034100	コネクタ(CON3:[ES])	Connector[171825-4]	1	P950B341P00
	C023	K14S95091068	コネクタ(CON3:[ES])	Connector[171822-4]	1	S950N910P68
	C024	K14S95091019	ターミナル(CON3:[ES])	Terminal[170204-1]	4	S950N910P19
	C025	K14M95064600	コネクタ(CON4:[X])	Connector[00-8263-0312-00-000]	1	P950A646P00
	C026	K14M95000067	コネクタ(CON4:[X])	Connector[60-8263-3038-15-000]	1	P950F000P67
	C027	K14M95062300	コネクタ(CON5:[Y])	Connector[00-8263-0412-00-001]	1	P950C623P00
	C028	K14M95000149	コネクタ(CON5:[Y])	Connector[60-8263-3048-15-001]	1	P950F001P49
	C029	K14M95000064	ターミナル(CON4:[X])	Terminal[60-8263-0513-00-808]	3	P950F000P64
	C030	K14M95000064	ターミナル(CON5:[Y])	Terminal[60-8263-0513-00-808]	3	P950F000P64

[D] ノイズフィルター基板 [PLK-B1-FIL]上の主要部品

MAIN PARTS OF NOISE FILTER PWB [PLK-B1-FIL]

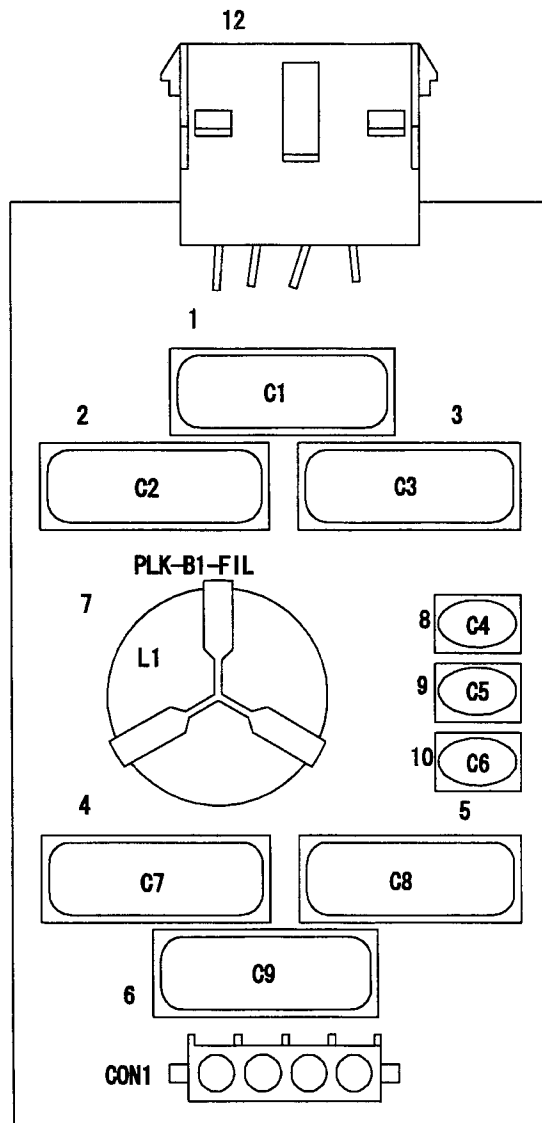

[D] ノイズフィルター基板 [PLK-B1-FIL]上の主要部品
 MAIN PARTS OF NOISE FILTER PWB [PLK-B1-FIL]

Fig. No.	変更 No.	部品コード Parts.No.	部品名	Description	使用個数 Amt.	Reg.	資材コード Ref.No.
							PLK-E
D001~D006		K14M11018800	コンデンサ(C1, C2, C3, C7, C8, C9)	Capacitor[ECQU2A224MN]	1	-	P110A188P00
D007		K14M19025200	コア(L1)	Core[NF05TL102W01]	1	-	P190A252P00
D008~D010		K14M11064400	コンデンサ(C4~C6)	Capacitor[DE7100752F472MVA1KC]	1	-	P110B644P00
D011		K14M95072000	コネクタ(CON1)	Connector[00-9090-04-0116-805]	1	-	P950C720P00
D012		K14M73826631	接続電線組立	Cord	1	-	E738D266G31

索引 (I) INDEX (I)

部品コード Parts.No.	ページ Page	Fig. No.	部品コード Parts.No.	ページ Page	Fig. No.	部品コード Parts.No.	ページ Page	Fig. No.
K14M10001300	P4	B012	K14M95009700	P6	C017			
K14M10007300	P4	B018	K14M95009700	P6	C018			
K14M10014700	P4	B105, B106	K14M95009700	P6	C019			
K14M10078400	P4	B019~B022	K14M95034100	P4	B120			
K14M10086700	P4	B126	K14M95034100	P6	C022			
K14M10087500	P4	B003	K14M95055100	P2	A001			
K14M11000878	P4	B113	K14M95055300	P4	B118			
K14M11001157	P4	B010	K14M95055400	P4	B117			
K14M11001208	P4	B042~B044	K14M95062300	P6	C027			
K14M11018100	P4	B002	K14M95062500	P2	A004			
K14M11018800	P8	D001~D006	K14M95062500	P6	C001			
K14M11038600	P4	B006~B009	K14M95064600	P6	C025			
K14M11050800	P4	B107, B108	K14M95066900	P2	A032			
K14M11050900	P4	B047, B048	K14M95067100	P2	A005			
K14M11054800	P4	B011	K14M95067300	P2	A007			
K14M11064400	P8	D008~D010	K14M95067400	P2	A002			
K14M15000256	P4	B057~B065	K14M95068300	P6	C013			
K14M15021300	P4	B094~B104	K14M95068400	P6	C009			
K14M15037600	P4	B082~B093	K14M95072000	P8	D011			
K14M15055100	P4	B024~B039	K14M95083800	P4	B122			
K14M16018200	P2	A024~A031	K14M95083800	P6	C002			
K14M16043600	P4	B109	K14M95086400	P2	A008			
K14M16043700	P4	B023	K14S15379501	P4	B074			
K14M16043800	P4	B045, B046	K14S18600139	P4	B081			
K14M16210300	P4	B049~B056	K14S46001138	P4	B114			
K14M16607400	P4	B128	K14S90345921	P4	B129~B163			
K14M16621800	P2	A019~A023	K14S95026103	P6	C007			
K14M18602500	P4	B076~B079	K14S95026142	P6	C005			
K14M18603500	P4	B124	K14S95026143	P4	B121			
K14M18611400	P4	B080	K14S95026143	P6	C011			
K14M18617400	P4	B125	K14S95026144	P4	B001			
K14M18618500	P4	B013	K14S95091019	P6	C024			
K14M18620900	P4	B066~B073	K14S95091068	P6	C023			
K14M19025200	P8	D007	M80AB1PMD	P4	B127			
K14M19030500	P4	B004						
K14M21000021	P4	B110, B111						
K14M21001106	P4	B040, B041						
K14M21001107	P4	B016						
K14M21001108	P4	B075						
K14M21024400	P4	B112						
K14M21024500	P4	B014						
K14M21722500	P4	B015						
K14M40079900	P4	B005						
K14M42928600	P2	A011~A018						
K14M46018200	P4	B115, B116						
K14M62434200	P4	B017						
K14M71626035	P6	C021						
K14M71928130	P6	C020						
K14M73826631	P8	D012						
K14M94300244	P6	C003, C004						
K14M95000020	P6	C008						
K14M95000064	P6	C029						
K14M95000064	P6	C030						
K14M95000067	P6	C026						
K14M95000146	P6	C012						
K14M95000149	P6	C028						
K14M95000163	P6	C014						
K14M95000164	P6	C010						
K14M95000935	P2	A003						
K14M95000936	P2	A009						
K14M95000937	P2	A006						
K14M95000937	P4	B123						
K14M95009500	P6	C006						
K14M95009700	P6	C015						
K14M95009700	P6	C016						

 **三菱電機株式会社** 〒100-8310 東京都千代田区丸の内2-2-3(三菱電機ビル)

お問い合わせは下記へどうぞ

F Aシステム事業本部 機器計画部 駆動機器グループ 〒104-6212 東京都中央区晴海1-8-12 オフィスタワー Z14階

代表電話番号 (03)6221-6160 代表FAX番号 (03)6221-6168

 **MITSUBISHI ELECTRIC CORPORATION**

FACTORY AUTOMATION SYSTEM

OFFICE TOWER "Z" 14F 8-12 1chome, Harumi CHUO-KU, TOKYO 104-6212, JAPAN

Phone : +81-3-6221-6060

Fax : +81-3-6221-6076